

LUXFORM
LIGHTING

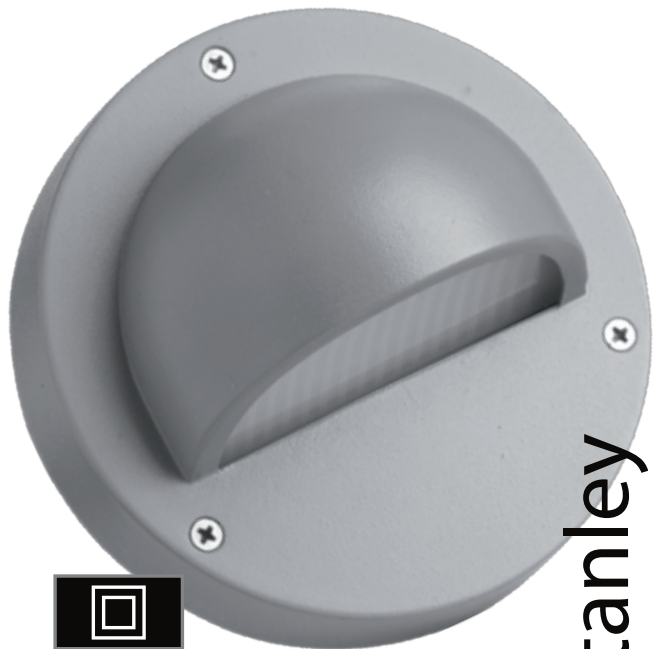









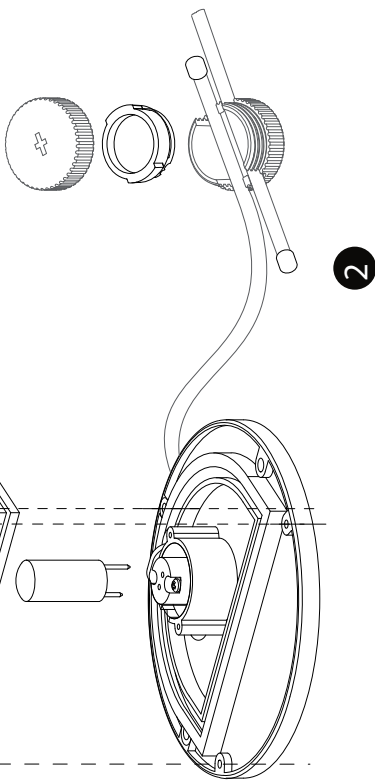
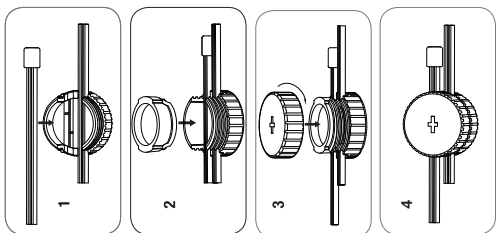
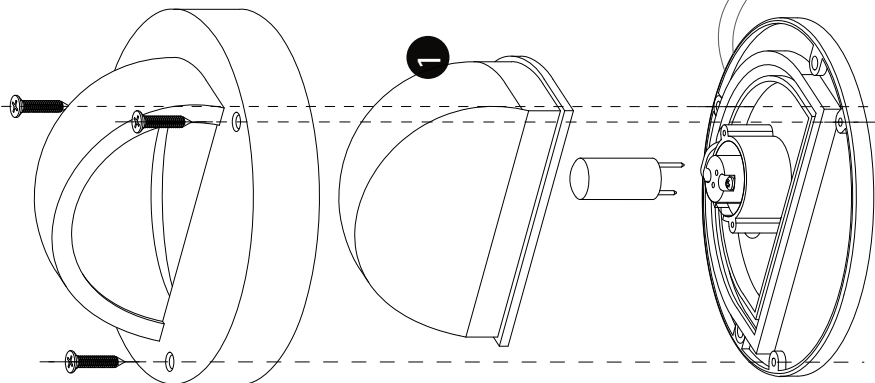

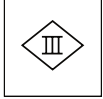
Stanley

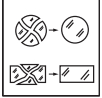
LUXFORM
GLOBAL BV

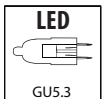
Luxform Global BV Transportstraat 1 8263 BW Kampen The Netherlands





- 
M1
- 
M2
- 
L1
- 
M12
- 
C2
- 
M18
- 
L6
- 
M19
- 
C1
- 
M6
- 
2Y Garantie Garantie Warranty
- 
CE